

Sistema K3+ / K3+ System

www.kryptonite.com

Sistema autoportante composto da spalle, ripiani e contenitori*.
Disponibile in varie finiture di colore, e due essenze di legno*,
è possibile richiedere un RAL Speciale.

* solo per la versione 36 cm.

Freestanding system composed of uprights, shelves and containers*.
Available in different colour finishings and in two types of wood*.
Special RAL can be required.

*only for the 36 cm version.



FINITURE / FINISHINGS

-  Alluminio anodizzato / Anodized aluminium
-  Bianco Opaco RAL 9010 / Mat white RAL 9010
-  Nero opaco RAL 9005 / Mat black RAL 9005
-  Bianco lucido RAL 9010 / White bright RAL 9010
-  Nero semilucido RAL 9005 / Semigloss black RAL 9005
-  Verde semilucido RAL 6003 / Semigloss green RAL 6003

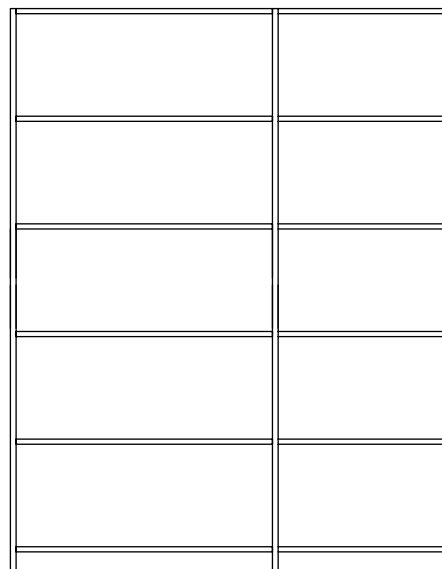

Sistema K3+ / K3+ System

PROFONDITA' 29 cm / 29 cm DEPTH

Ripiani / Shelves

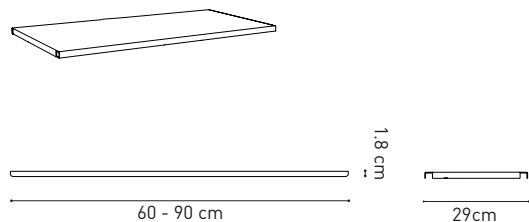

	60 cm	90 cm
Portata kg Load capacity kg	25	15
Capienza Libri Books capacity	30	45

Spalle / Uprights

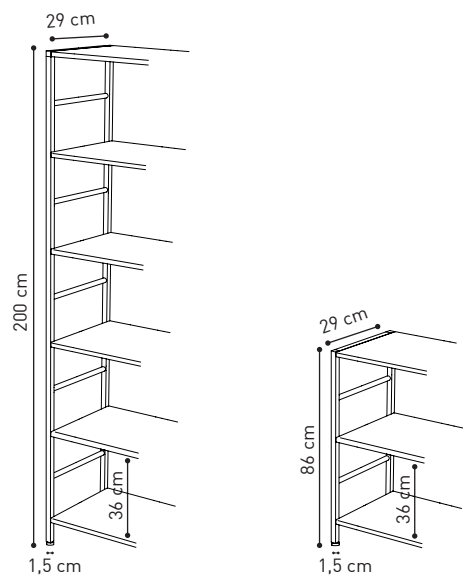

PROFONDITA' 36 cm / 36 cm DEPTH

Ripiani / Shelves

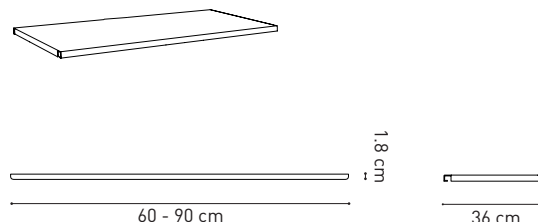

	60 cm	90 cm
Portata kg Load capacity kg	25	15
Capienza Libri Books capacity	30	45

Spalle / Uprights

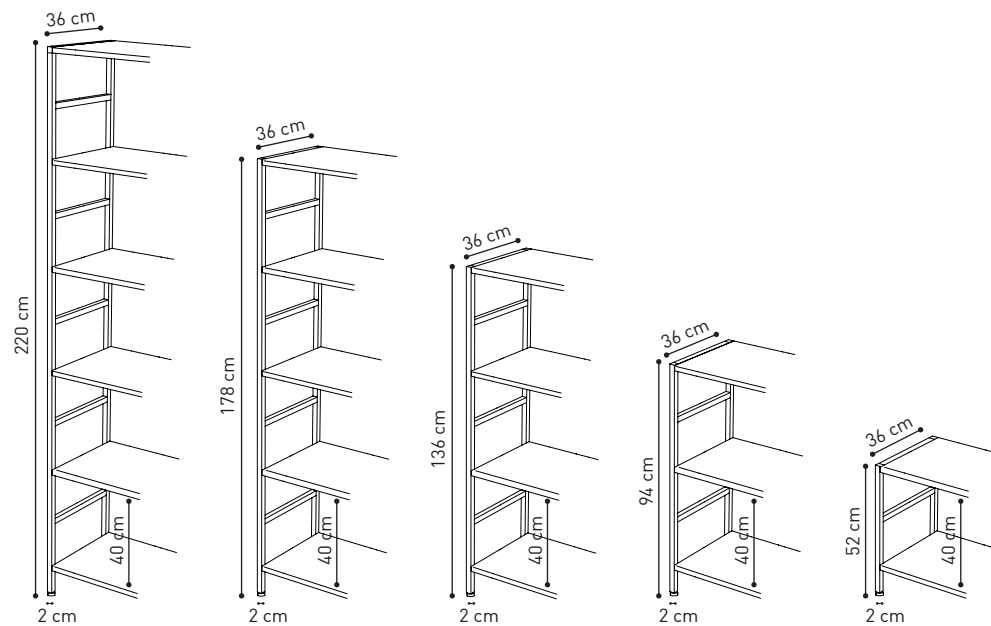

Sistema K3+ / K3+ System

Disponibile solo per profondità 36 cm /
Available only for 36 cm depth

www.kryptonite.com

Cassettiera doppia /
Double drawer

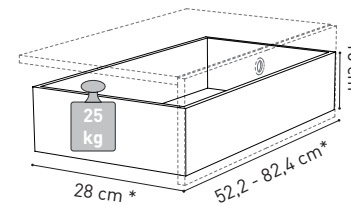
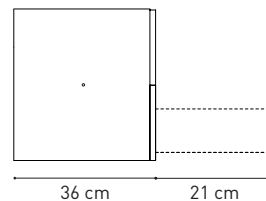
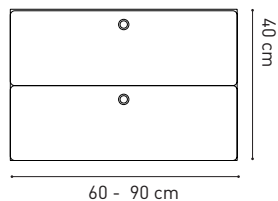
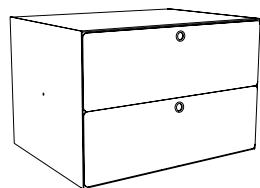

* Ingombro interno del cassetto
* Internal dimensions of the drawer

Cassettone /
Big drawer

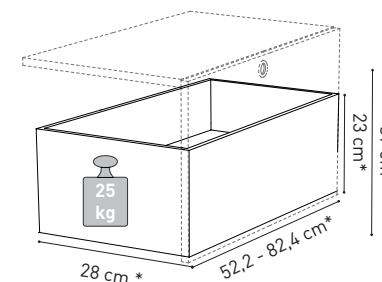
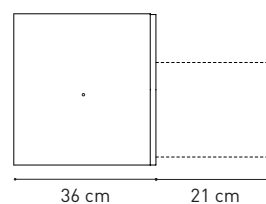
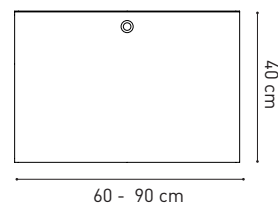
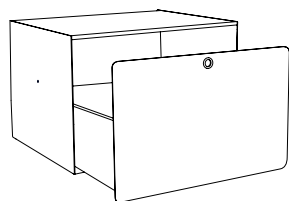

* Ingombro interno del cassetto
* Internal dimensions of the drawer

Ribaltina /
Unit with top down door

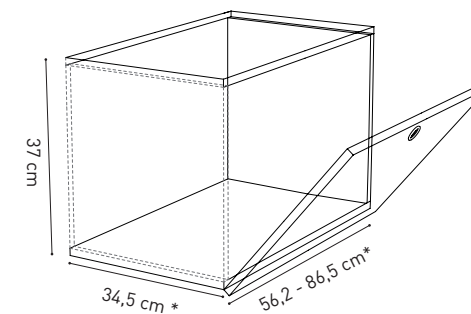
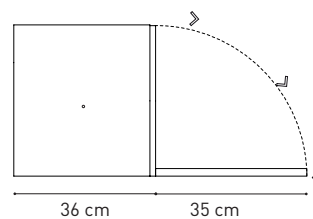
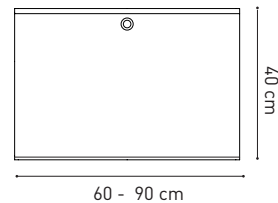
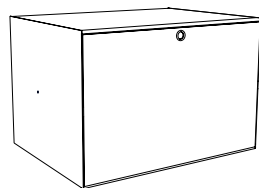

* Ingombro interno
* Internal dimensions

Pensile /
Unit with bottom up door

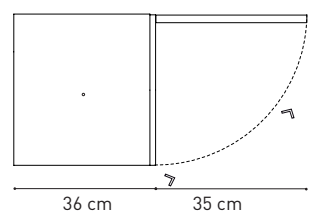
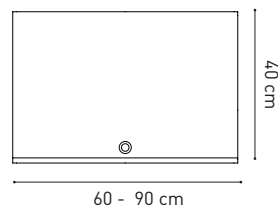
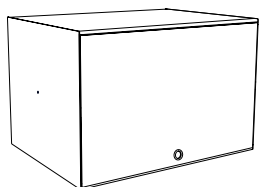

Sistema K3+ / K3+ System

Disponibile solo per profondità 36 cm /
Available only for 36 cm depth

www.kryptonite.com

Cassettiera doppia /
Double drawer

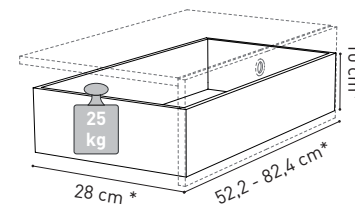
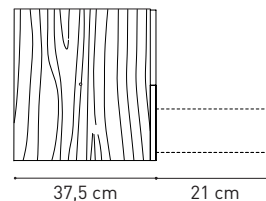
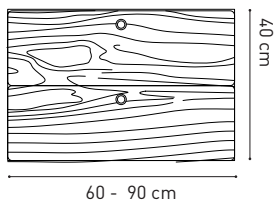
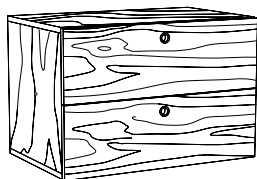

* Ingombro interno del cassetto
* Internal dimensions of the drawer

Cassettone /
Big drawer

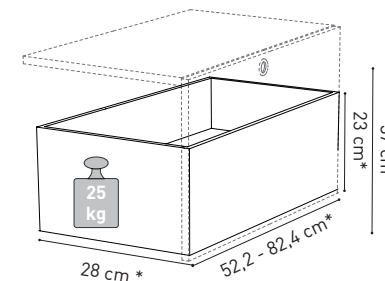
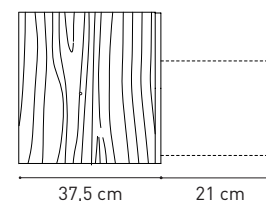
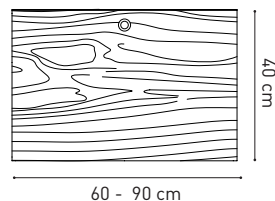
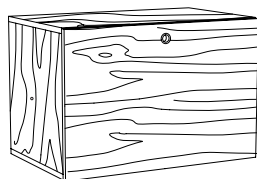

* Ingombro interno del cassetto
* Internal dimensions of the drawer

Ribaltina /
Unit with top down door

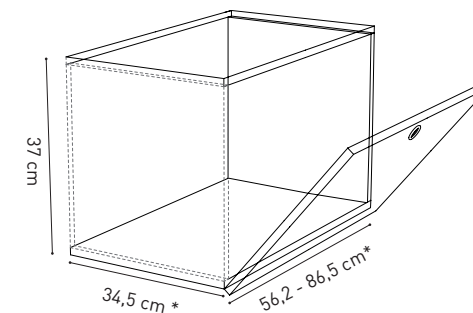
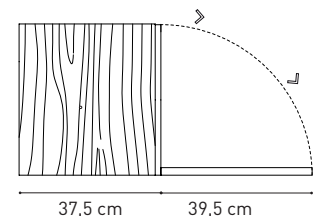
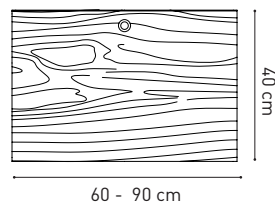
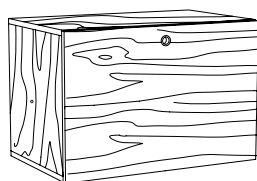

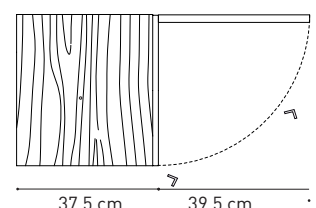
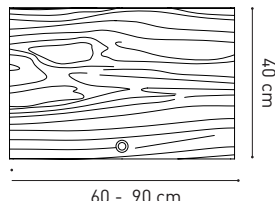
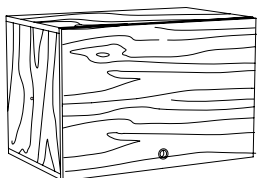

* Ingombro interno
* Internal dimensions

Pensile /
Unit with bottom up door



FINITURE / FINISHINGS

- Maggio 2019
-  Legno Rovere / Oak Wood
 -  Legno Noce Canaletto / Walnut Wood

Sistema K3+ / K3+ System

Disponibile solo per profondità 36 cm /
Available only for 36 cm depth

www.kryptonite.com

Contenitore con antine / Storage with door

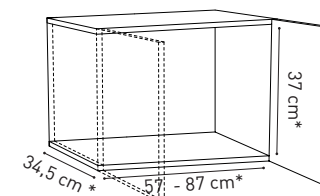
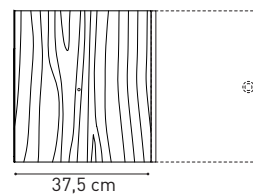
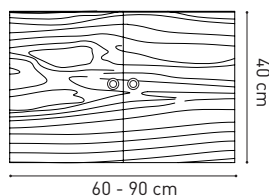
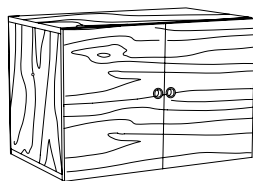

* Nella larghezza di 60 cm è prevista un'anta unica.
Al momento dell'ordine indicare il lato dell'apertura
*In the 60 cm width it's provided only one door.
When ordering, indicate the side of the opening

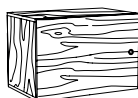

* Ingombro interno
* Internal dimensions

Contenitore h. 40 / Storage unit h.40

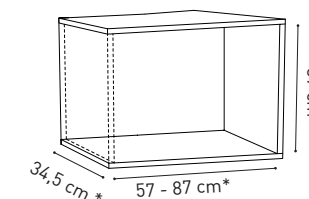
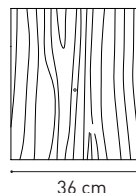
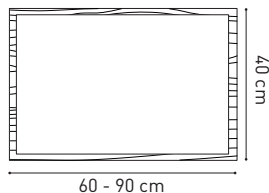
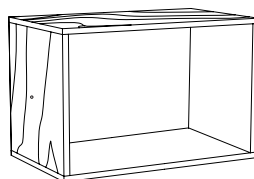

* Disponibile anche in legno laccato bianco opaco
*Also available in mat white lacquered wood

* Ingombro interno
* Internal dimensions

Contenitore con cassetto / Storage unit with drawer

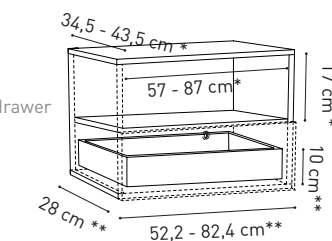
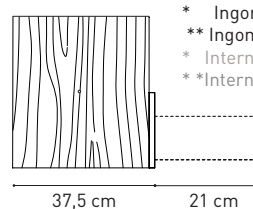
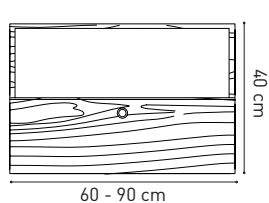
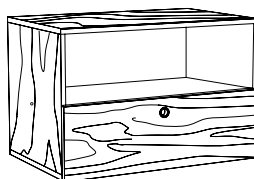

* Ingombro interno
** Ingombro interno Cassetto
* Internal dimensions
** Internal dimensions of the drawer

Piano* / Shelf*

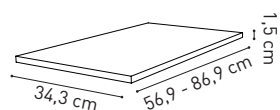

Divisorio / Divider

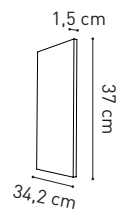

Contenitori compatibili / Compatible containers

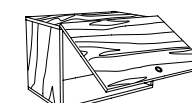
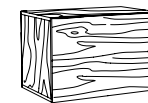
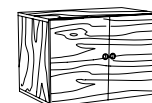

Guida alla manutenzione / Maintenance guide

COMPONENTI IN ALLUMINIO

Manutenzione ordinaria con detergente per piatti e un panno umido.

Sono severamente vietati prodotti a base di acetone, aceto o ammoniacca, spugne abrasive e prodotti a base di creme abrasive o particolarmente aggressivi.

ALUMINIUM COMPONENTS

Ordinary service with dish detergents and a wet cloth.

Acetone, vinegar or ammonia based and particularly aggressive products are strictly forbidden, as much as abrasive sponges or lotions.

COMPONENTI IN LEGNO

Il legno è un materiale vivo, caratterizzato da variazioni naturali a livello di tonalità e struttura, quindi l'incidenza della luce e dei raggi solari comportano normali variazioni di colore. Le superfici sono sigillate da una vernice di alta qualità, è vivamente sconsigliato sottoporre il legno ad aria troppo umida o troppo secca. In caso contrario, il legno si deforma malgrado la vernice applicate. Per la pulizia ordinaria è sufficiente una passata con un panno morbido o al massimo con un panno leggermente umido. L'utilizzo di prodotti abrasivi per la pulizia (panni in microfibra, spugne per lucidare ecc...) rischia di graffiare le superfici. Le macchie di prodotti alimentari di origine animale grassa o vegetale, bevande e altri liquidi acidi possono compromettere definitivamente la superficie.

WOODEN COMPONENTS

Being an alive material, wood is characterized by natural variations of hue and structure, artificial or sun lights can cause colour variations. Surfaces are protected by a high quality coating: don't expose wood to either too wet or too dry air or it will deform despite the applied paint. A soft cloth, dry or a bit humid, is sufficient for ordinary cleanings. The use of abrasive products (microfiber cloths, polishing sponges, ...) is not recommended as they might scratch the surfaces. Stains from vegetal and animal food, or from drinks and other acid liquids, might compromise the surfaces.

